

OVIVO
ELECTRIC

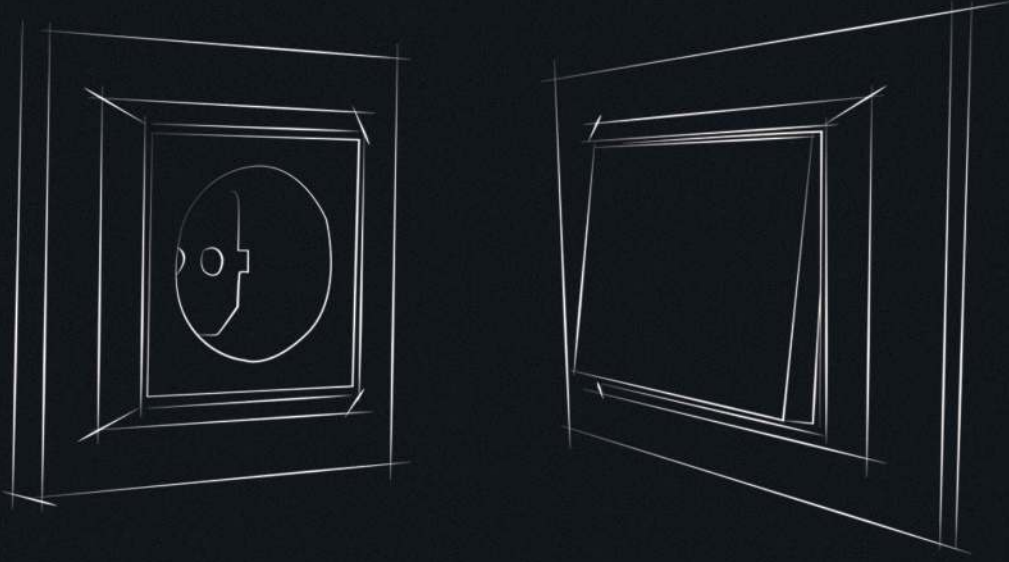

2023-1

FIYAT
LİSTESİ



SANAL POS İLE E-Tahsilatta Hızlı Ödeme Farkını Yaşayın

tahsilat.ovivoelektrik.com.tr

Paraf.

Garanti
bonus

bankKart
Combo

QNB
FINANSBANK



maximum

VakıfBank
WORLD



Netahsilat altyapısı ve yazılımları uluslararası güvenlik standardı olan PCI DSS standartlarındadır. Kredi kartı bilgilerinin güvenliği için 256 Bit SSL kullanılmakta, ödeme ve tahsilat işlemleri 3D secure güvenlikle gerçekleştirilebilmektedir. Yazılımların çalıştığı donanımlar 3 katmanlı güvenlik sistemleriyle korunmakta ve 3 katmanlı yedekleme yapılmaktadır.

**“Yine bir ilk, yine bir yenilik,
yeni seri, çok yakında..”**

YENI

QUANTUM

Sıva Altı Anahtar ve Priz Serisi



Tarzını yansıtır





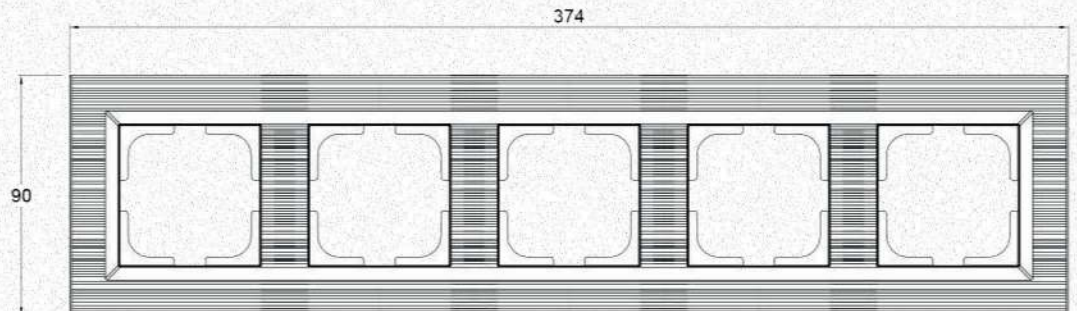
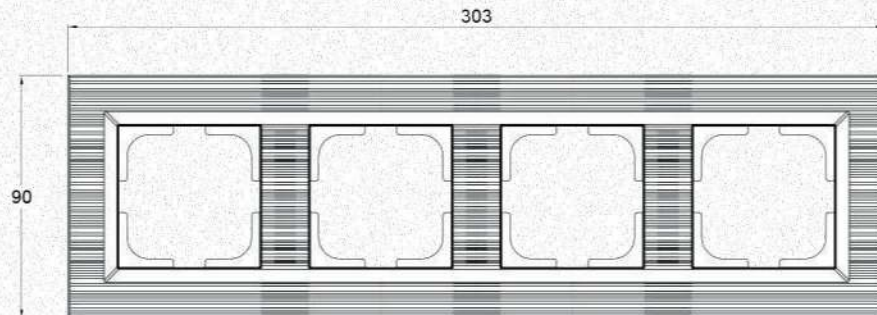
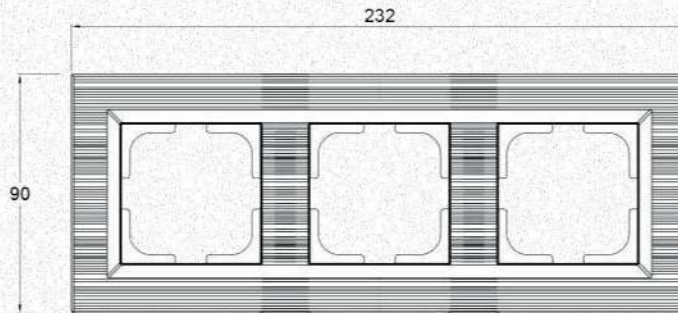
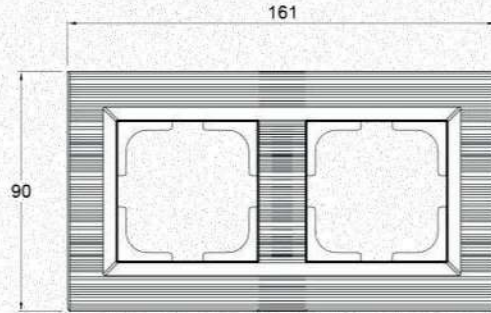
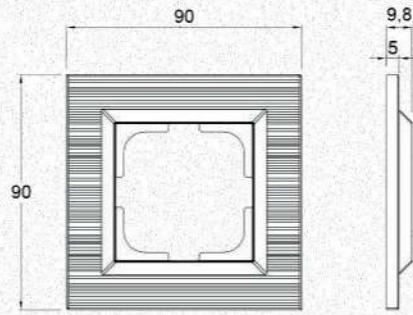

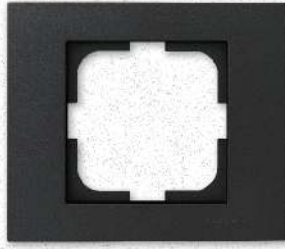

Grano Metallic - Tekli Çerçeve

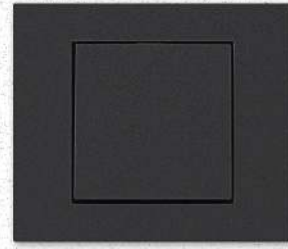

Grano Metallic - Anahtar

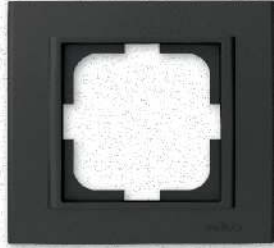

Mina Metallic - Tekli Çerçeve



Mina Metallic - Anahtar



Loft Metallic - Tekli Çerçeve



Loft Metallic - Anahtar



Quantum - Tekli Çerçeve



Quantum - Anahtar



Elements - Tekli Çerçeve



Elements - Anahtar

YENİ

QUANTUM

Sıva Altı Anahtar ve Priz Serisi



Q46
ANTRASİT
405-350000-096



Q22
INOX
405-340000-096



Q04
MANYETİK GRİ
405-310000-096



Q03
METAL MAVİ
405-300000-096



Q02
GÜMÜŞ
405-320000-096

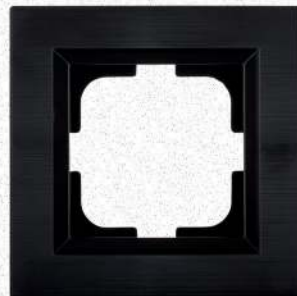

Q21
SİYAH
405-360000-096



Q24
BAKIR
405-330000-096

405-XX0000-096

XX - Üst çerçeve kodu karşılığı : 32=Gümüş, 30=Metal Mavi, 31=Manyetik Gri, 36=Siyah, 34=Inox, 33=Bakır, 35=Antrasit
Çoklu çerçeveler yatay ve dikey kullanıma uygundur.

Quantum serisi, (Mekanizma + Tuş / Kapak) ve (Çerçeve) şeklinde 2 parça olarak satılmaktadır.

YENİ

QUANTUM
İKİLİ TOPRAKLI ÇERÇEVE



Q46
ANTRASİT
405-350000-266



Q22
INOX
405-340000-266



Q04
MANYETİK GRİ
405-310000-266



Q03
METAL MAVİ
405-300000-266



Q02
GÜMÜŞ
405-320000-266

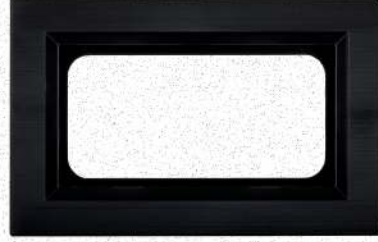

Q21
SİYAH
405-360000-266



Q24
BAKIR
405-330000-266

405-XX0000-266

XX - Üst çerçeve kodu karşılığı : 32=Gümüş, 30=Metal Mavi, 31=Manyetik Gri, 36=Siyah, 34=Inox, 33=Bakır, 35=Antrasit
Çoklu çerçeveler yatay ve dikey kullanıma uygundur.
Quantum serisi, (Mekanizma + Tuş / Kapak) ve (Çerçeve) şeklinde 2 parça olarak satılmaktadır.

YENİ

QUANTUM

Sıva Altı Anahtar ve Priz Serisi

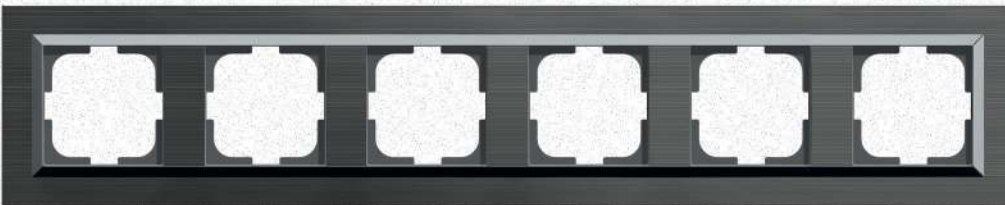
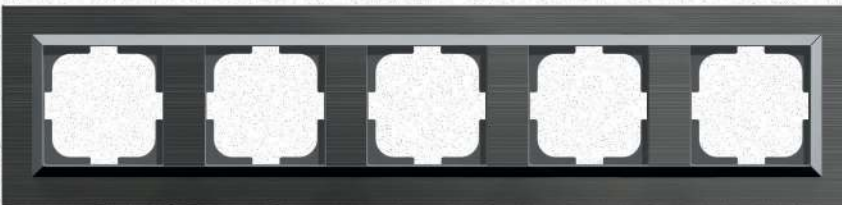
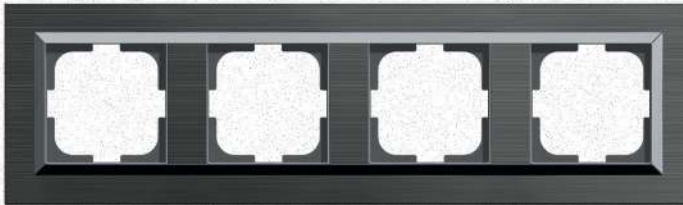
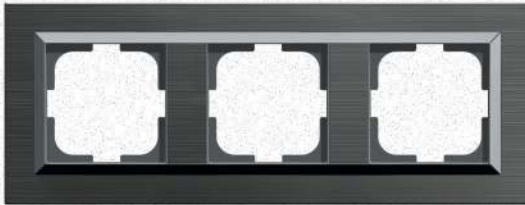
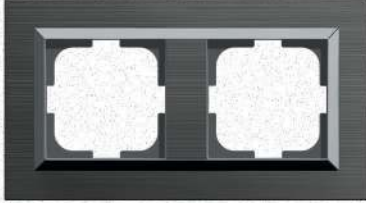

405-XX0000-096

XX - Üst çerçeve kodu karşılığı : 32=Gümüş, 30=Metal Mavi, 31=Manyetik Gri, 36=Siyah, 34=Inox, 33=Bakır, 35=Antrasit
Çoklu çerçeveler yatay ve dikey kullanıma uygundur.

Quantum serisi, (Mekanizma + Tuş / Kapak) ve (Çerçeve) şeklinde 2 parça olarak satılmaktadır.

YENİ

QUANTUM

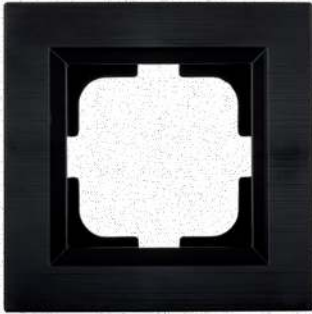

QUANTUM
ÇERÇEVE

Referans No	Ürün Adı	Kutudaki Adet	Kolideki Adet	Liste Fiyatı (TL)
405-XX0000-096	Tekli Çerçeve	24	240	76,50
405-XX0000-226	İkili Çerçeve	12	120	145,50
405-XX0000-227	Üçlü Çerçeve	12	120	213,00
405-XX0000-228	Dörtlü Çerçeve	12	120	283,00
405-XX0000-250	Beşli Çerçeve	12	120	351,00
405-XX0000-251	Altılı Çerçeve	12	120	444,50



QUANTUM
İKİLİ PRİZ ÇERÇEVE

Referans No	Ürün Adı	Kutudaki Adet	Kolideki Adet	Liste Fiyatı (TL)
405-XX0000-266	İkili Priz Çerçeve	12	120	130,00

405-XX0000-096

XX - Üst çerçeve kodu karşılığı : 32=Gümüş, 30=Metal Mavi, 31=Manyetik Gri, 36=Siyah, 34=Inox, 33=Bakır, 35=Antrasit
Çoklu çerçeveler yatay ve dikey kullanıma uygundur.

Quantum serisi, (Mekanizma + Tuş / Kapak) ve (Çerçeve) şeklinde 2 parça olarak satılmaktadır.

Grano Metallic Çerçeve

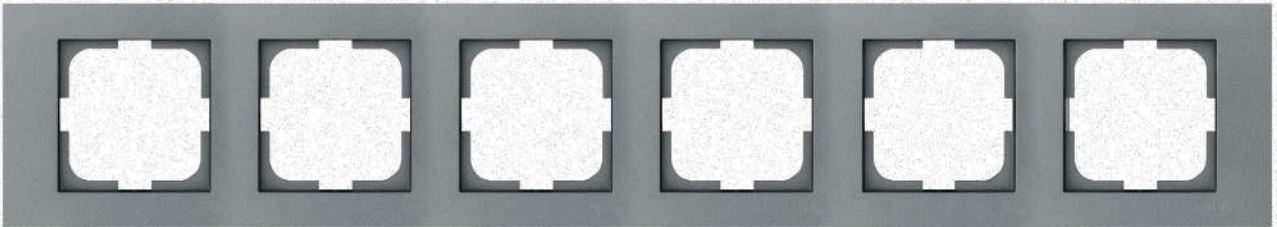
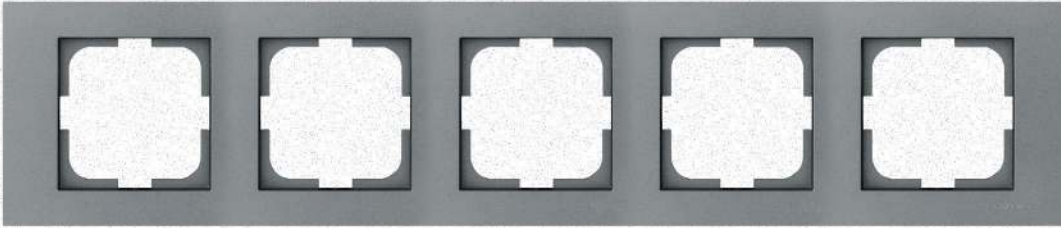
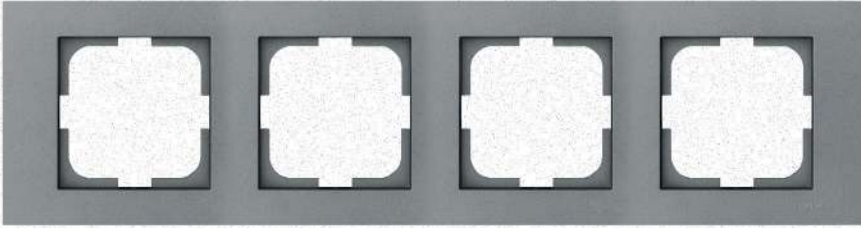
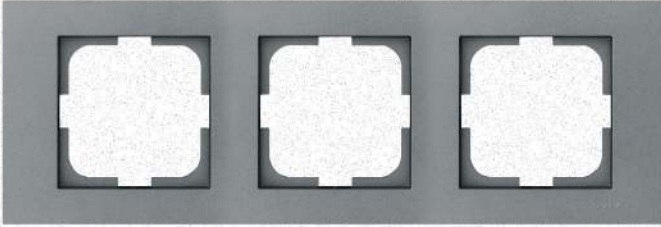
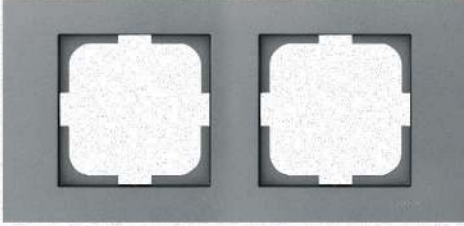
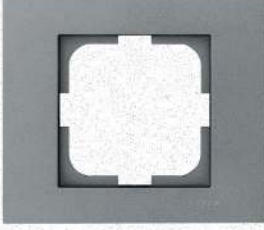

400-XX0000-096

XX - Çerçeve kodu karşılığı : 10 = Silver, 11 = Füme, 12 = Titanyum, 13 = Antrasit, 17 = Metalik Siyah, 19 = Mocha

Çoklu çerçeveler yatay ve dikey kullanıma uygundur. Mina serisi, (Mekanizma + Tuş / Kapak) ve (Çerçeve) şeklinde 2 parça olarak satılmaktadır.

Grano Metallic

Sıva Altı Anahtar ve Priz Serisi Renk ve Çerçeve Seçenekleri

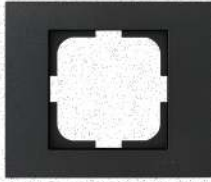

Grano Metallic / Siyah



Grano Metallic / Füme



Grano Metallic / Antrasit



Grano Metallic / Titanyum



Grano Metallic / Gümüş

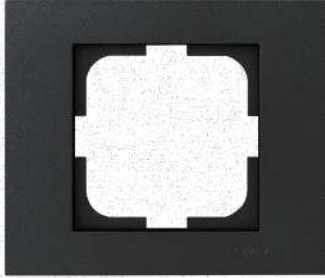

Grano Metallic Çerçeveler



Grano Metallic / Mocha

Referans No	Ürün Adı	Kutudaki Adet	Kolideki Adet	Liste Fiyatı (TL)
400-XX0000-096	Tekli Çerçeve	24	240	43,00
400-XX0000-226	İkili Çerçeve	12	120	99,50
400-XX0000-227	Üçlü Çerçeve	12	120	145,50
400-XX0000-228	Dörtlü Çerçeve	12	120	191,00
400-XX0000-250	Beşli Çerçeve	12	120	238,00
400-XX0000-251	Altılı Çerçeve	12	48	288,50

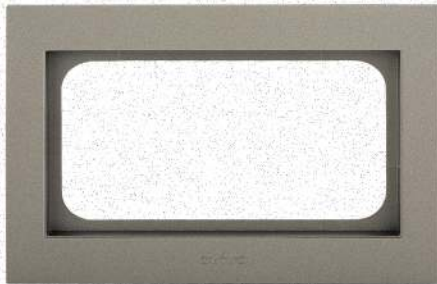

Grano Metallic İkili Priz Çerçevesi

Referans No	Ürün Adı	Kutudaki Adet	Kolideki Adet	Liste Fiyatı (TL)
400-XX0000-266	İkili Priz Çerçevesi	12	120	55,00

400-XX0000-096

XX - Çerçeve kodu karşılığı : 10 = Silver, 11 = Füme, 12 = Titanyum, 13 = Antrasit, 17 = Metalik Siyah, 19 = Mocha

Çoklu çerçeveler yatay ve dikey kullanıma uygundur. Mina serisi, (Mekanizma + Tuş / Kapak) ve (Çerçeve) şeklinde 2 parça olarak satılmaktadır.

Mina Metallic Çerçeve

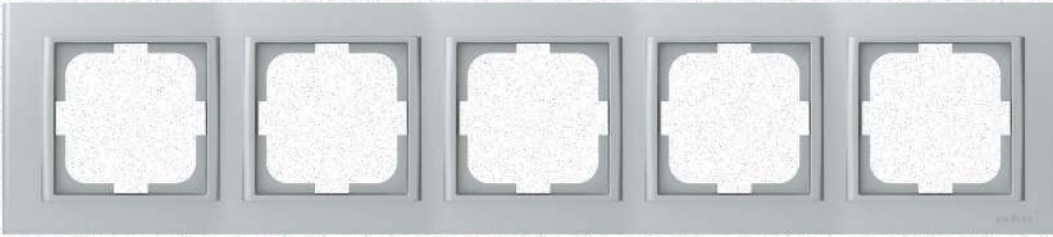
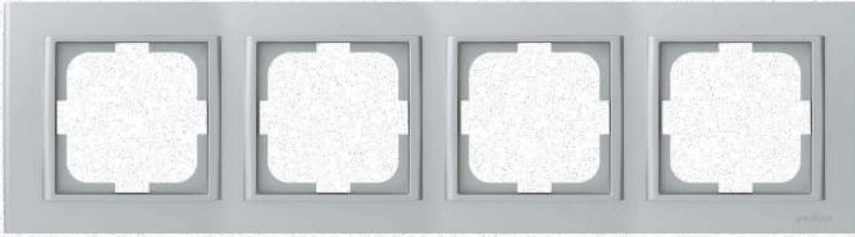
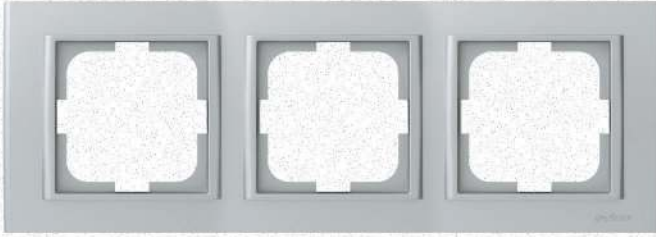
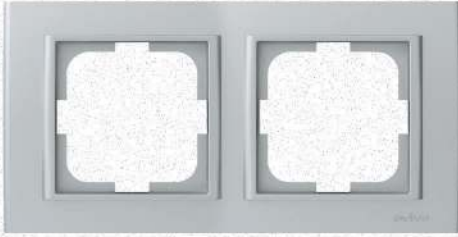
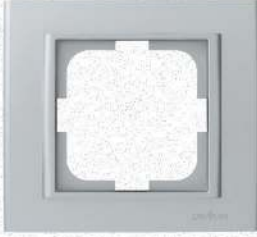

401-XX0000-096

XX - Çerçeve kodu karşılığı : 10 = Silver, 11 = Füme, 12 = Titanyum, 13 = Antrasit, 17 = Metalik Siyah

Çoklu çerçeveler yatay ve dikey kullanıma uygundur. Mina serisi, (Mekanizma + Tuş / Kapak) ve (Çerçeve) şeklinde 2 parça olarak satılmaktadır.

Mina Metallic

Sıva Altı Anahtar ve Priz Serisi Renk ve Çerçeve Seçenekleri

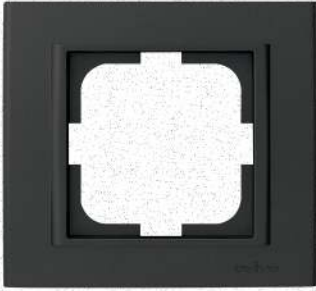

Mina Metallic / Siyah



Mina Metallic / Füme

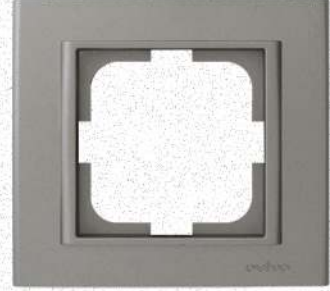

Mina Metallic / Antrasit



Mina Metallic / Titanyum

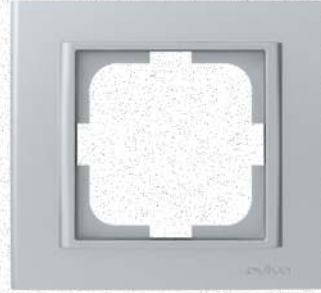

Mina Metallic / Gümüş



Mina Metallic Çerçeveler

Referans No	Ürün Adı (Mekanizma + Tuş/Kapak)	Kutudaki Adet	Kolideki Adet	Liste Fiyatı (TL)
401-XX0000-096	Tekli Çerçeve	24	240	43,00
401-XX0000-226	İkili Çerçeve	12	120	99,50
401-XX0000-227	Üçlü Çerçeve	12	120	145,50
401-XX0000-228	Dörtlü Çerçeve	12	120	191,00
401-XX0000-250	Beşli Çerçeve	12	120	238,00

401-XX0000-096

XX - Çerçeve kodu karşılığı : 10 = Silver, 11 = Füme, 12 = Titanyum, 13 = Antrasit, 17 = Metalik Siyah

Çoklu çerçeveler yatay ve dikey kullanıma uygundur. Mina serisi, (Mekanizma + Tuş / Kapak) ve (Çerçeve) şeklinde 2 parça olarak satılmaktadır.

Loft

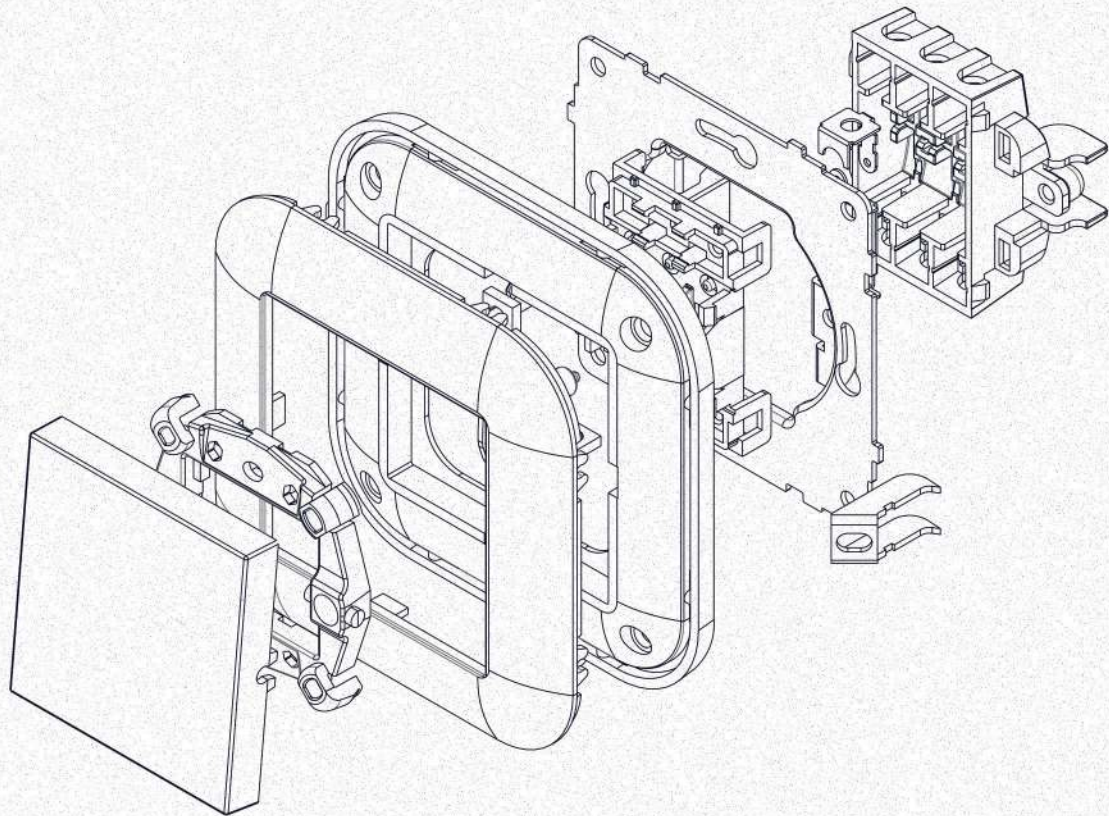
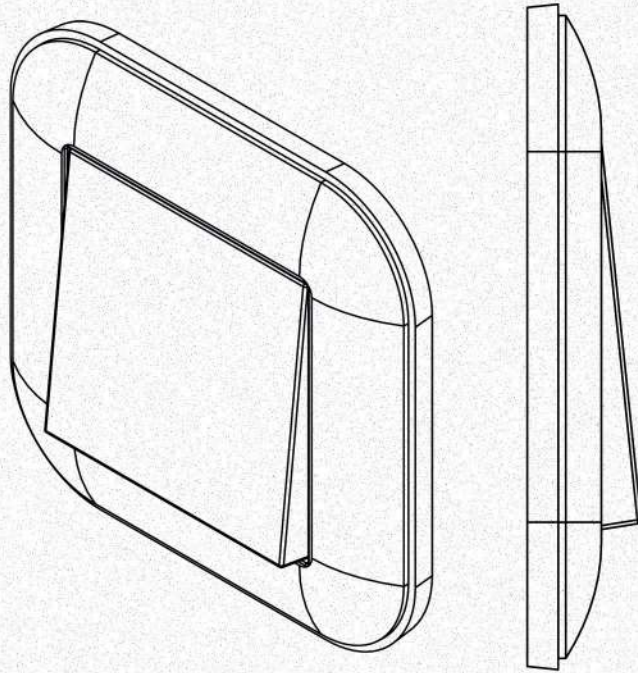

Loft Metallic

Sıva Altı Anahtar ve Priz Serisi Renk ve Çerçeve Seçenekleri



Loft Metallic / Siyah



Loft Metallic / Füme



Loft Metallic / Antrasit



Loft Metallic / Mocha



Loft Metallic / Gümüş



Loft Metallic / M. Beyaz



Loft Metallic
Çerçeveler



Loft Metallic Plus Çerçeve

Referans No	Ürün Adı (Mekanizma + Tuş/Kapak)	Kutudaki Adet	Kolideki Adet	Liste Fiyatı (TL)
404-XX00YY-096	Tekli Çerçeve	24	240	62,50
404-XX00YY-097	Tekli Çerçeve Plus	24	240	71,50
404-XX00YY-226	İkili Çerçeve	12	120	142,50
404-XX00YY-227	Üçlü Çerçeve	12	120	201,50
404-XX00YY-228	Dörtlü Çerçeve	12	120	267,00
404-XX00YY-250	Beşli Çerçeve	12	120	332,00

404-XX00YY-096

XX - Üst çerçeve kodu karşılığı : 10 = Silver, 11 = Füme, 13 = Antrasit, 17 = Metalik Siyah, 18 = Metalik Beyaz, 19 = Mocha

YY - Alt çerçeve kodu karşılığı : 10 = Silver, 11 = Füme, 13 = Antrasit, 17 = Metalik Siyah, 18 = Metalik Beyaz, 19 = Mocha

Çoklu çerçeveler yatay ve dikey kullanıma uygundur. Loft serisi, (Mekanizma + Tuş / Kapak) ve (Çerçeve) şeklinde 2 parça olarak satılmaktadır.

Loft Chrome

Sıva Altı Anahtar ve Priz Serisi Renk ve Çerçeve Seçenekleri



Loft Chrome Çerçeveler

Referans No	Ürün Adı (Mekanizma + Tuş/Kapak)	Kutudaki Adet	Kolideki Adet	Liste Fiyatı (TL)
404-210017-096	Tekli Çerçeve	24	240	313,00
404-210017-097	Tekli Çerçeve Plus	24	240	718,00
404-210017-226	İkili Çerçeve	12	120	377,50
404-210017-227	Üçlü Çerçeve	12	120	596,00
404-210017-228	Dörtlü Çerçeve	12	120	1.055,00
404-210017-250	Beşli Çerçeve	12	120	1.230,00

Çoklu çerçeveler yatay ve dikey kullanıma uygundur.
Loft serisi, (Mekanizma + Tuş / Kapak) ve (Çerçeve) şeklinde 2 parça olarak satılmaktadır.

Elements Aluminium

Sıva Altı Anahtar ve Priz Serisi Renk ve Çerçeve Seçenekleri



Elements Aluminium
M. Siyah / Gümüş



Elements Aluminium
Gümüş / M. Siyah



Elements Aluminium
Bronz / M. Siyah



Alüminyum Çerçeveler

Referans No	Ürün Adı (Mekanizma + Tuş/Kapak)	Kutudaki Adet	Kolideki Adet	Liste Fiyatı (TL)
403-XX00YY-096	Tekli Çerçeve	6	240	561,50
403-XX00YY-226	İkili Çerçeve	6	120	952,50
403-XX00YY-227	Üçlü Çerçeve	6	120	1.343,00
403-XX00YY-228	Dörtlü Çerçeve	6	120	1.733,50
403-XX00YY-250	Beşli Çerçeve	6	120	2.138,00

403-XX00YY-096

XX - Üst çerçeve kodu karşılığı : 50 = Siyah, 51 = Bronz, 52 = Gümüş. YY - Alt çerçeve kodu karşılığı : 10 = Silver, 17 = Metalik Siyah
Elements serisi, (Mekanizma + Tuş / Kapak) ve (Çerçeve) şeklinde 2 parça olarak satılmaktadır.

Elements Orient

Sıva Altı Anahtar ve Priz Serisi Renk ve Çerçeve Seçenekleri



Elements Orient
Krom / M. Siyah



Elements Orient
Füme / M. Siyah



Elements Orient
Inox / M. Siyah



Elements Orient
Altın / M. Siyah



Orient
Çerçeveler

Referans No	Ürün Adı (Mekanizma + Tuş/Kapak)	Kutudaki Adet	Kolideki Adet	Liste Fiyatı (TL)
403-XX0017-096	Tekli Çerçeve	6	240	646,50
403-XX0017-226	İkili Çerçeve	6	120	1.107,00
403-XX0017-227	Üçlü Çerçeve	6	120	1.470,00
403-XX0017-228	Dörtlü Çerçeve	6	120	1.779,00

403-XX0017-096

XX - Üst çerçeve kodu karşılığı : 80 = Füme, 81 = Altın, 82 = Krom, 83 = Inox,
Elements serisi, (Mekanizma + Tuş / Kapak) ve (Çerçeve) şeklinde 2 parça olarak satılmaktadır.

Elements Akrilik Cam

Sıva Altı Anahtar ve Priz Serisi Renk ve Çerçeve Seçenekleri



Elements Akrilik Cam
Kesekağıdı / M. Siyah



Elements Akrilik Cam
Siyah / M. Gümüş



Elements Akrilik Cam
Beyaz / M. Siyah

Referans No	Ürün Adı (Mekanizma + Tuş/Kapak)	Kutudaki Adet	Kolideki Adet	Liste Fiyatı (TL)
403-XX00YY-096	Tekli Çerçeve	6	240	436,00
403-XX00YY-226	İkili Çerçeve	6	120	794,50
403-XX00YY-227	Üçlü Çerçeve	6	120	1.147,00
403-XX00YY-228	Dörtlü Çerçeve	6	120	1.542,50
403-XX00YY-250	Beşli Çerçeve	6	120	1.955,00

403-XX00YY-096

XX - Üst çerçeve kodu karşılığı : 70 = Beyaz, 71 = Siyah, 72 = Kese Kağıdı. YY - Alt çerçeve kodu karşılığı : 10 = Silver, 17 = Metalik Siyah
Elements serisi, (Mekanizma + Tuş / Kapak) ve (Çerçeve) şeklinde 2 parça olarak satılmaktadır.



ELEMENTS MASIF AHŞAP



ELEMENTS CEVİZ AHŞAP

Referans No	Ürün Adı (Mekanizma + Tuş/Kapak)	Kutudaki Adet	Kolideki Adet	Liste Fiyatı (TL)
403-XX00YY-096	Tekli Çerçeve	6	240	612,00
403-XX00YY-226	İkili Çerçeve	6	120	1.066,00
403-XX00YY-227	Üçlü Çerçeve	6	120	1.519,50
403-XX00YY-228	Dörtlü Çerçeve	6	120	1.932,50
403-XX00YY-250	Beşli Çerçeve	6	120	2.326,00

403-XX00YY-096

XX - Üst çerçeve kodu karşılığı : 40 = Bambu, 41 = Sapelli

YY - Alt çerçeve kodu karşılığı : 10 = Silver, 17 = Metalik Siyah

Elements serisi, (Mekanizma + Tuş / Kapak) ve (Çerçeve) şeklinde 2 parça olarak satılmaktadır.

Anahtar Grubu



Anahtar
600-0002XX-200



Permütatör (Ara Veavien)
600-0002XX-214



Komütatör
600-0002XX-202



Üçlü Anahtar
600-0002XX-254



Light Anahtarı
600-0002XX-205



Jaluzi Kumanda Anahtarı
600-0002XX-216



Kapı Otomatiği Anahtarı
600-0002XX-204



Yaysız Jaluzi Kumanda Anahtarı
600-0022XX-216



Zil Anahtarı
600-0002XX-207



İmplus Komütatör (Light + Light)
600-0002XX-220



Veavien
600-0002XX-209



DND/MUR
600-0002XX-251



Komütatör Veavien
600-0002XX-211



Müzik Yayın Anahtarı
600-0002XX-252

Led Işıklı Anahtar Grubu



Işıklı Anahtar
600-0002XX-201



Light Anahtarı
610-0002XX-205



Işıklı Komütatör
600-0002XX-203



Kapı Otomatığı Anahtarı
610-0002XX-204



Işıklı Light Anahtarı
600-0002XX-206



Zil Anahtarı
610-0002XX-207



Işıklı Veavien
600-0002XX-210



Veavien
610-0002XX-209



Komütatör Veavien
610-0002XX-211

Slim Anahtar Grubu



Anahtar
610-0002XX-200



Üçlü Anahtar
610-0002XX-254



Komütatör
610-0002XX-202



Jaluzi Kumanda Anahtarı
610-0002XX-216

Priz Grubu



Topraklı Priz
600-0003XX-217



1X USB Şarj Prizi 5V-2A
600-0003XX-245



Topraklı Priz (Çocuk Korumalı)
600-0003XX-218



2X USB Şarj Prizi 5V-2A
600-0003XX-247



Kapaklı Topraklı Priz
600-0003XX-249

TV - Uydu - Sat Prizleri



Kapaklı Topraklı Priz (Çocuk Korumalı)
600-0003XX-243



TV Anten Prizi (Ekranlı Geçişli)
600-0003XX-237
TV Anten Prizi (Ekran Sonlu)
600-0003XX-238



Ups Topraklı Priz (Çocuk Korumalı)
600-0003XX-219



Uydu Prizi (Tekli, F Tipi Konnektör, Sonlu)
600-0003XX-231
Uydu Prizi (Tekli, F Tipi Konnektör, Ekranlı)
600-0003XX-232



İkili Topraklı Priz (Modül + Kapak)
600-0003XX-907



TV - Sat Prizi, İkili (Geçişli)
600-0003XX-239
TV - Sat Prizi, İkili (Geçişli)
600-0003XX-240



Kablo Çıkışı
600-0003XX-241

İletişim Priz Grubu



Nümeris Telefon Prizi
(1*RJ11-623 Kablolu, 4 Kontaklı)
600-0003XX-221



1X HDMI Prizi
600-0003XX-236
2X HDMI Prizi
600-0003XX-269



Nümeris Telefon Priz
(1*RJ11 - Cat 3 Kablosuz)
600-0003XX-223



USB Data Prizi
600-0003XX-235



İkili Nümeris Telefon Priz
(2*RJ11 - Cat 3)
600-0003XX-222



Data + HDMI Prizi
600-0003XX-242



Data + Nümeris
(Cat 6 + RJ11 Cat 3)
600-0003XX-234



Data + USB Data Prizi
600-0003XX-244



Tekli Data Prizi
(1*RJ45 Cat6)
600-0003XX-229



1X Fiber Optik
600-0003XX-255
2X Fiber Optik
600-0003XX-270



İkili Data Prizi
(2*RJ45 Cat6)
600-0003XX-230



Fiber Optik + HDMI Prizi
610-0002XX-254



Data Priz (Jaksız)
600-0003XX-233



Fiber Optik + Data Prizi
610-0002XX-216

Dimmerler



Dimmer 800W
600-0003XX-212
Dimmer 500W (Vavien)
600-0003XX-248



11 Pinli 3x10 A Röle
200-000100-007

Elektronik Ürünler



Energy Saver Mikro Switch (Gecikmeli)
600-0003XX-262
Energy Saver Mikro Switch
600-0003XX-263



TV - Sat Prizi, İkili (**BOŞ KAPAK**)



Metalik Siyah
600-000217-200



Metalik Beyaz
600-000218-200



Mocha
600-000219-200



Silver
600-000210-200



Titanyum
600-000212-200



Füme
600-000211-200



Antrasit
600-000213-200

600-0002XX-200

XX - Kodu karşılığı : 10 = Silver, 11 = Füme, 12 = Titanyum, 13 = Antrasit, 17 = Metalik Siyah, 18 = Metalik Beyaz, 19 = Mocha
Anahtar, priz mekanizmalar, (Mekanizma + Tuş / Kapak) ve (Çerçeve) şeklinde 2 parça olarak satılmaktadır.
Farklı "Energy Saver" çeşitleri için lütfen firmamız ile iletişime geçiniz.

600-0002XX-200

XX - Kodu karşılığı : 10 = Silver, 11 = Fme, 12 = Titanyum, 13 = Antrasit, 17 = Metalik Siyah, 18 = Metalik Beyaz, 19 = Mocha
Anahtar, priz mekanizmalar, (Mekanizma + Tuş / Kapak) ve (Çerçeve) Őeklinde 2 parça olarak satılmaktadır.
Farklı "Energy Saver" çeşitleri için ltfen firmamız ile iletiŐime geçiniz.



Metalik Siyah
600-000217-200



Fme
600-000211-200



Titanyum
600-000212-200



Silver
600-000210-200



Antrasit
600-000213-200

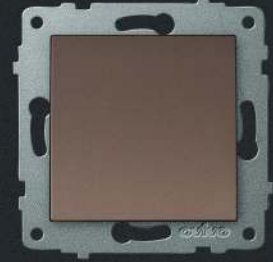

Mocha
600-000219-200



Metalik Beyaz
600-000218-200

RENKLİ MEKANİZMA FİYATLARI



Referans No	Ürün Adı (Mekanizma + Tuş/Kapak)	Kutudaki Adet	Kolideki Adet	Liste Fiyatı (TL)
600-0002XX-200	Anahtar	12	120	107,00
600-0002XX-202	Komütatör	12	120	138,00
600-0002XX-205	Light Anahtarı	12	120	112,00
600-0002XX-204	Kapı Otomatığı Anahtarı	12	120	112,00
600-0002XX-207	Zil Anahtarı	12	120	112,00
600-0002XX-209	Veavien	12	120	132,00
600-0002XX-211	Komütatör Veavien	12	120	193,00
600-0002XX-214	Permütatör (Ara Veavien)	12	120	176,50
600-0002XX-254	Üçlü Anahtar	12	120	178,00
600-0002XX-216	Jaluzi Kumanda Anahtarı	12	120	214,50
600-0022XX-216	Yaysız Jaluzi Kumanda Anahtarı	12	120	225,00
600-0002XX-220	İmplus Komütatör (Light + Light)	12	120	208,50
600-0002XX-251	DND/MUR İç Ünite Komütatör	12	120	219,50
600-0002XX-252	Müzik Yayın Anahtarı	12	120	1.194,00

Led Işıklı Anahtar

600-0002XX-201	Işıklı Anahtar	12	60	183,00
600-0002XX-203	Işıklı Komütatör	12	60	217,50
600-0002XX-206	Işıklı Light Anahtarı	12	60	183,00
600-0002XX-210	Işıklı Veavien	12	60	206,00

Slim Anahtar Grubu

610-0002XX-200	Anahtar	12	120	139,50
610-0002XX-202	Komütatör	12	120	175,50
610-0002XX-205	Light Anahtarı	12	120	139,00
610-0002XX-204	Kapı Otomatığı Anahtarı	12	120	139,00
610-0002XX-207	Zil Anahtarı	12	120	139,00
610-0002XX-209	Veavien	12	120	167,00
610-0002XX-211	Komütatör Veavien	12	60	205,50
610-0002XX-254	Üçlü Anahtar	12	60	198,00
610-0002XX-216	Jaluzi Kumanda Anahtarı	12	60	236,00
610-0002XX-214	Permütatör (Ara Veavien)	12	60	238,00
610-0002XX-220	İmplus Komütatör (Light + Light)	12	60	230,00

Priz Grubu

600-0003XX-217	Topraklı Priz	12	120	129,00
600-0003XX-218	Topraklı Priz (Çocuk Korumalı)	12	120	169,00
600-0003XX-249	Kapaklı Topraklı Priz	12	120	172,00
600-0003XX-243	Kapaklı Topraklı Priz (Çocuk Korumalı)	12	120	189,00
600-0003XX-219	Ups Topraklı Priz (Çocuk Korumalı)	12	120	199,00
600-000301-907	İkili Topraklı Priz (Modül + Kapak I)	12	72	200,00
600-0003XX-245	1X USB Şarj Prizi 5V-2A	12	60	1.565,50
600-0003XX-247	2X USB Şarj Prizi 5V-2A	12	60	1.856,50
400-XX0300-907	Mina İkili Topraklı Priz (ÇFRCEVELI)	12	72	226,00



Metalik Siyah
600-000217-200



Füme
600-000211-200



Titanium
600-000212-200



Silver
600-000210-200



Antrasit
600-000213-200



Mocha
600-000219-200

Referans No	Ürün Adı (Mekanizma + Tuş/Kapak)	Kutudaki Adet	Kolideki Adet	Liste Fiyatı (TL)
TV - Uydu - Sat Prizleri				
600-0003XX-237	TV Anten Prizi (Ekranlı Geçişli)	12	120	198,00
600-0003XX-238	TV Anten Prizi (Ekranlı Sonlu)	12	120	198,00
600-0003XX-231	Uydu Prizi (Tekli, F Tipi Konnektör, Sonlu)	12	120	158,50
600-0003XX-232	Uydu Prizi (Tekli, F Tipi Konnektör, Ekranlı)	12	120	317,50
600-0003XX-239	TV - Sat Prizi, İkili (Geçişli)	12	60	857,50
600-0003XX-240	TV - Sat Prizi, İkili (Sonlu)	12	60	857,50
600-0003XX-241	Kablo Çıkışı	12	60	111,00

İletişim Priz Grubu

600-0003XX-221	Nümeris Telefon Prizi (1*RJ11-623 Kablolu , 4 Kontaklı)	12	120	157,50
600-0003XX-223	Nümeris Telefon Priz (1*RJ11 - Cat 3 Kablosuz	12	120	185,50
600-0003XX-222	kili Nümeris Telefon Priz (2*RJ11 - Cat 3)	12	120	273,00
600-0003XX-234	Data + Nümeris (Cat 6 + RJ11 Cat 3)	12	120	481,50
600-0003XX-229	Tekli Data Prizi (1*RJ45 Cat6)	12	120	413,00
600-0003XX-230	İkili Data Prizi (2*RJ45 Cat6)	12	120	684,00
600-0003XX-233	Data Priz (Jaksız)	12	120	134,00
600-0003XX-236	1X HDMI Prizi	12	120	790,50
600-0003XX-269	2XHDMI Prizi	12	120	1.185,00
600-0003XX-242	Data + HDMI Prizi	12	120	1.349,00
600-0003XX-244	Data + USB Data Prizi	12	120	1.238,00
600-0003XX-255	1XFiber Optik	12	120	318,50
600-0003XX-270	2XFiber Optik	12	120	478,00
600-0003XX-235	USB Data Prizi	12	120	451,50

Dimmerler

600-0003XX-212	Dimmer 800W	12	120	1.087,00
600-0003XX-248	Dimmer 500W (Veavien)	12	120	1.756,50

Elektronik Ürünler

600-0003XX-262	Energy Saver Mikro Switch Gecikmeli	12	120	1.848,00
600-0003XX-263	Energy Saver Mikro Switch	12	120	1.129,50
200-000100-007	11 Pinli 3x10 A Röle	12	120	3.250,00
120-011803-103	Optik Yedek Pvc Kart	12	120	240,00

600-0002XX-200

XX - Kodu karşılığı: 10 = Silver, 11 = Füme, 12 = Titanyum, 13 = Antrasit, 17 = Metalik Siyah, 18 = Metalik Beyaz, 19 = Mocha Anahtar, priz mekanizmalar, (Mekanizma + Tuş / Kapak) ve (Çerçeve) şeklinde 2 parça olarak satılmaktadır. Farklı "Energy Saver" çeşitleri için lütfen firmamız ile iletişime geçiniz.



ovivo

ovivo

GRANO WOODS

Sıva Altı Anahtar ve Priz Serisi Renk ve Çerçeve Seçenekleri



Grano Woods / Masif / Anahtar



Grano Woods / Ceviz / Anahtar



Grano Woods
Çerçevesel

Referans No	Ürün Adı (Mekanizma + Tuş/Kapak)	Kutudaki Adet	Kolideki Adet	Liste Fiyatı (TL)
400-XX0000-096	Tekli Çerçeve	12	240	87,50
400-XX0000-226	İkili Çerçeve	12	120	130,50
400-XX0000-227	Üçlü Çerçeve	12	120	156,00
400-XX0000-228	Dörtlü Çerçeve	12	120	192,50
400-XX0000-250	Beşli Çerçeve	12	120	245,50

400-XX0000-096

XX - Çerçeve kodu karşılığı : 14 = Masif, 15 = Ceviz

Çoklu çerçeveler yatay ve dikey kullanıma uygundur.

Grano serisi, (Mekanizma + Tuş / Kapak) ve (Çerçeve) şeklinde 2 parça olarak satılmaktadır.

GRANO WOODS MEKANİZMA

Referans No	Ürün Adı (Mekanizma + Tuş/Kapak)	Kutudaki Adet	Kolideki Adet	Liste Fiyatı (TL)
600-0002XX-200	Anahtar	12	120	146,00
600-0002XX-202	Komütatör	12	120	179,50
600-0002XX-205	Light Anahtarı	12	120	149,00
600-0002XX-204	Kapı Otomatığı Anahtarı	12	120	149,00
600-0002XX-207	Zil Anahtarı	12	120	149,00
600-0002XX-209	Veavien	12	120	170,50
600-0002XX-211	Komütatör Veavien	12	120	231,50
600-0002XX-214	Permütatör (Ara Veavien)	12	120	193,00
600-0002XX-254	Üçlü Anahtar	12	120	216,50
600-0002XX-216	Jaluzi Kumanda Anahtarı	12	120	205,50
600-0022XX-216	Yaysız Jaluzi Kumanda Anahtarı	12	120	215,50
600-0002XX-220	İmplus Komütatör (Light + Light)	12	120	195,00
600-0002XX-251	DND/MUR İç Ünite Komütatör	12	120	204,50
600-0002XX-252	Müzik Yayın Anahtarı	12	120	1.189,50



Led Işıklı Anahtar

600-0002XX-201	Işıklı Anahtar	12	60	205,50
600-0002XX-203	Işıklı Komütatör	12	60	253,50
600-0002XX-206	Işıklı Light Anahtarı	12	60	205,50
600-0002XX-210	Işıklı Veavien	12	60	240,00

Priz Grubu

600-0003XX-217	Topraklı Priz	12	120	159,50
600-0003XX-218	Topraklı Priz (Çocuk Korumalı)	12	120	178,00
600-0003XX-249	Kapaklı Topraklı Priz	12	120	167,00
600-0003XX-243	Kapaklı Topraklı Priz (Çocuk Korumalı)	12	120	191,50
600-0003XX-219	Ups Topraklı Priz (Çocuk Korumalı)	12	120	218,50
600-000301-907	İkili Topraklı Priz (Kıvılcık Korumalı)	12	120	280,00
600-0003XX-245	1X USB Şarj Prizi 5V-2A	12	120	1.363,00
600-0003XX-247	2X USB Şarj Prizi 5V-2A	12	120	1.608,00

Referans No	Ürün Adı (Mekanizma + Tuş/Kapak)	Kutudaki Adet	Kolideki Adet	Liste Fiyatı (TL)
TV - Uydu - Sat Prizleri				
600-0003XX-237	TV Anten Prizi (Ekranlı Geçişli)	12	120	239,00
600-0003XX-238	TV Anten Prizi (Ekranlı Sonlu)	12	120	239,00
600-0003XX-231	Uydu Prizi (Tekli, F Tipi Konnektör, Sonlu)	12	120	167,00
600-0003XX-232	Uydu Prizi (Tekli, F Tipi Konnektör, Ekranlı)	12	120	304,00
600-0003XX-239	TV - Sat Prizi, İkili (Geçişli)	12	60	867,00
600-0003XX-240	TV - Sat Prizi, İkili (Sonlu)	12	60	867,00
600-0003XX-241	Kablo Çıkışı	12	60	135,00

İletişim Priz Grubu

600-0003XX-221	Nümeris Telefon Prizi (1*RJ11-623 Kablolu , 4 Kontaklı)	12	120	171,00
600-0003XX-223	Nümeris Telefon Priz (1*RJ11 - Cat 3 Kablosuz	12	120	200,00
600-0003XX-222	kili Nümeris Telefon Priz (2*RJ11 - Cat 3)	12	120	293,50
600-0003XX-234	Data + Nümeris (Cat 6 + RJ11 Cat 3)	12	120	440,00
600-0003XX-229	Tekli Data Prizi (1*RJ45 Cat6)	12	120	382,00
600-0003XX-230	İkili Data Prizi (2*RJ45 Cat6)	12	120	680,00
600-0003XX-233	Data Priz (Jaksız)	12	120	165,00
600-0003XX-236	1X HDMI Prizi	12	120	802,00
600-0003XX-269	2XHDMI Prizi	12	120	1.200,00
600-0003XX-242	Data + HDMI Prizi	12	120	1.260,00
600-0003XX-244	Data + USB Data Prizi	12	120	1.150,00
600-0003XX-255	1XFiber Optik	12	120	290,00
600-0003XX-270	2XFiber Optik	12	120	435,00
600-0003XX-235	USB Data Prizi	12	120	531,00

Dimmerler

600-0003XX-212	Dimmer 800W	12	120	1.080,00
600-0003XX-248	Dimmer 500W (Veavien)	12	120	1.730,00

Elektronik Ürünler

600-0003XX-262	Energy Saver Mikro Switch Gecikmeli	12	120	1.820,00
600-0003XX-263	Energy Saver Mikro Switch	12	120	1.145,00
200-000100-007	11 Pinli 3x10 A Röle	12	120	3.250,00
120-011803-103	Optik Yedek Pvc Kart	12	120	240,00

Loft Natural



Mina Natural



Grano Natural

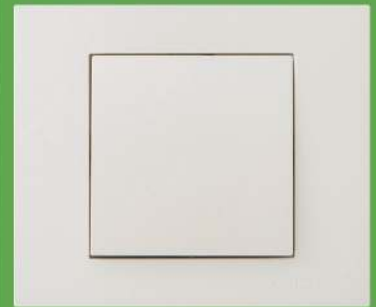

Çerçeve/Modül Sistemi

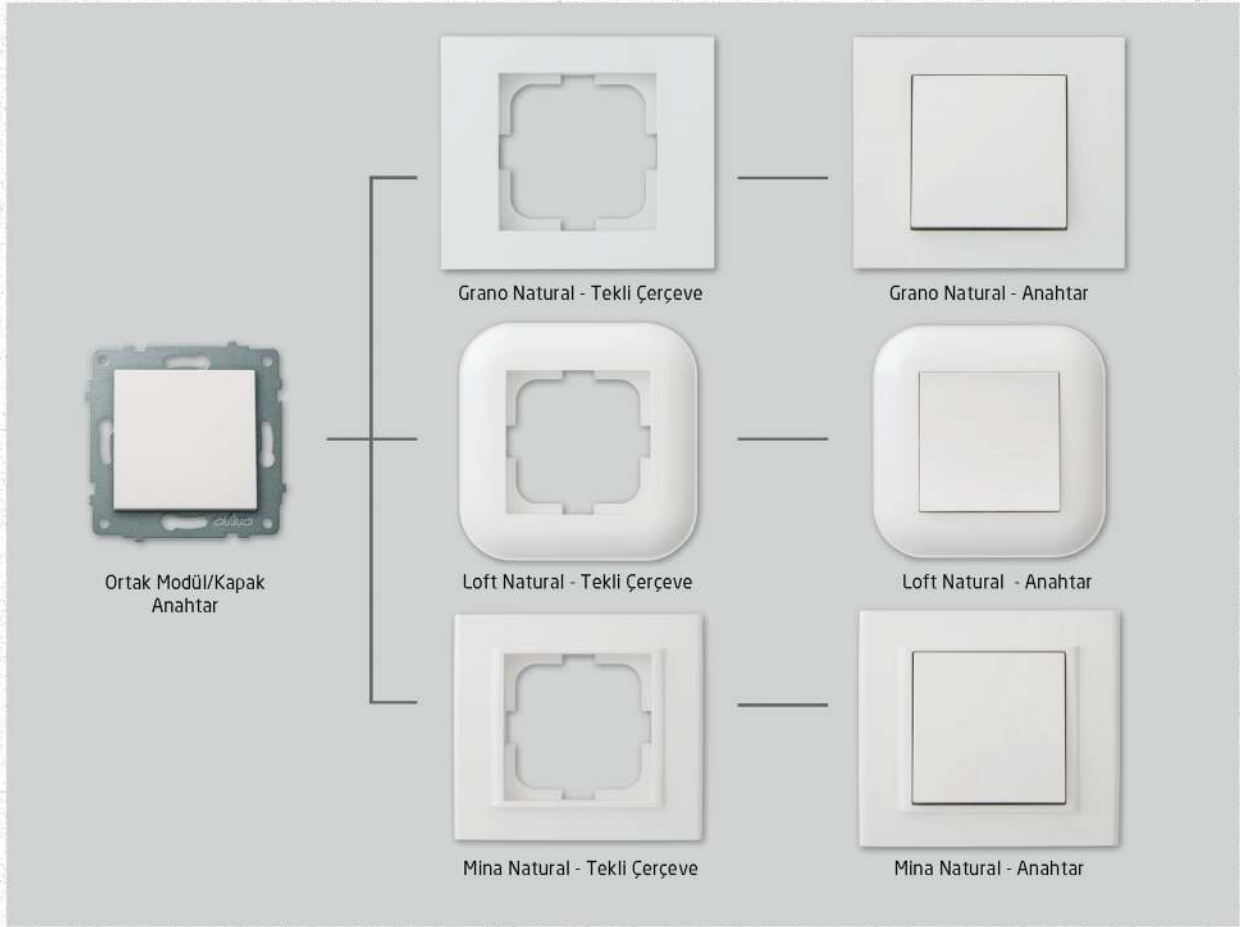

Kod Sistemi

Ürün kodlarındaki sayılar ne anlama gelir?

Ürün Serisi Kodu	Çerçeve Çeşidi Kodu	Renk Kodu	Modül/Kapak Kodu
4 0 0	0 2		2 0 0
<p>Grano Natural</p> <p>Loft Color</p> <p>Mina Metallic</p> <p>Quantum</p>	<p>Beyaz</p> <p>Krem</p> <p>Füme</p> <p>Mocha</p>	<p>Gri</p> <p>Kese Kağıdı</p> <p>Siyah</p> <p>Beyaz</p>	<p>Anahtar</p> <p>Topraklı Priz</p> <p>Numeris Priz</p> <p>Dimmer</p>

Grano Natural

Sıva Altı Anahtar ve Priz Serisi Renk ve Çerçeve Seçenekleri

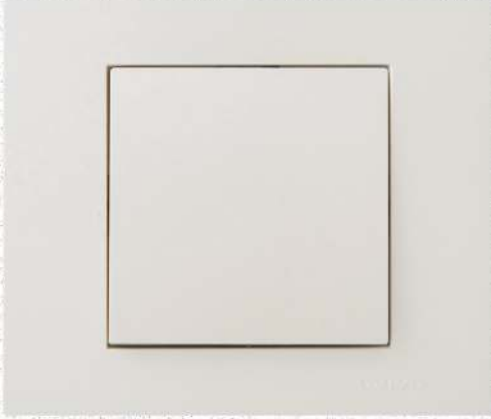

Grano Natural / Beyaz / Anahtar

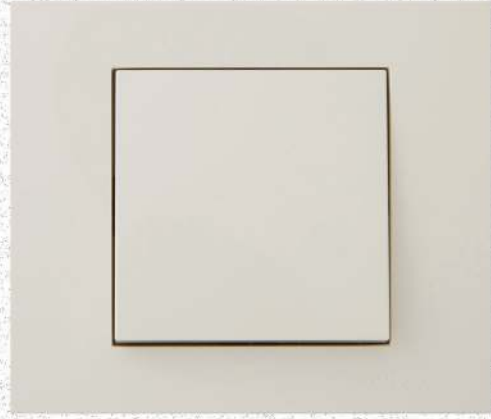

Grano Natural / Krem / Anahtar

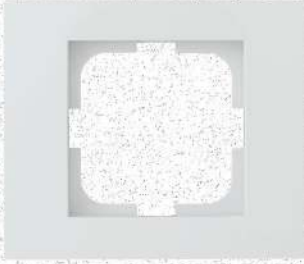

Grano Natural Çerçeveler

Referans No	Ürün Adı	Kutudaki Adet	Kolideki Adet	Liste Fiyatı (TL)
400-XX0000-096	Tekli Çerçeve	24	240	10,00
400-XX0000-226	İkili Çerçeve	12	120	70,50
400-XX0000-227	Üçlü Çerçeve	12	120	92,50
400-XX0000-228	Dörtlü Çerçeve	12	120	115,50
400-XX0000-250	Beşli Çerçeve	12	120	147,00
400-XX0000-251	Altılı Çerçeve	12	48	188,50



Grano Natural İkili Priz Çerçeveler

Referans No	Ürün Adı	Kutudaki Adet	Kolideki Adet	Liste Fiyatı (TL)
400-XX0000-266	İkili Priz Çerçeve	12	120	30,00

400-XX0000-096

XX - Çerçeve kodu karşılığı : 01 = Beyaz, 02 = Krem

Çoklu çerçeveler yatay ve dikey kullanıma uygundur. Grano serisi, (Mekanizma + Tuş / Kapak) ve (Çerçeve) şeklinde 2 parça olarak satılmaktadır.

Mina Natural

Sıva Altı Anahtar ve Priz Serisi Renk ve Çerçeve Seçenekleri



Mina Natural / Beyaz / Anahtar



Mina Natural / Krem / Anahtar



Mina Natural
Çerçeveler

Referans No	Ürün Adı	Kutudaki Adet	Kolideki Adet	Liste Fiyatı (TL)
401-XX0000-096	Tekli Çerçeve	24	240	10,00
401-XX0000-226	İkili Çerçeve	12	120	70,50
401-XX0000-227	Üçlü Çerçeve	12	120	92,50
401-XX0000-228	Dörtlü Çerçeve	12	120	115,50
401-XX0000-250	Beşli Çerçeve	12	120	147,00

401-XX0000-096

XX - Çerçeve kodu karşılığı : 01 = Beyaz, 02 = Krem

Çoklu çerçeveler yatay ve dikey kullanıma uygundur. Mina serisi, (Mekanizma + Tuş / Kapak) ve (Çerçeve) şeklinde 2 parça olarak satılmaktadır.

Loft Natural

Sıva Altı Anahtar ve Priz Serisi Renk ve Çerçeve Seçenekleri



Loft Komb.
Beyaz - Gri / Anahtar



Loft Komb.
Beyaz - K.Kağıdı / Anahtar



Loft Komb.
Beyaz - Siyah / Anahtar



Loft Natural Çerçeveler

Referans No	Ürün Adı	Kutudaki Adet	Kolideki Adet	Liste Fiyatı (TL)
404-XX00YY-096	Tekli Çerçeve	24	240	42,50
404-XX00YY-097	Tekli Çerçeve Plus	24	240	49,50
404-XX00YY-226	İkili Çerçeve	12	120	114,00
404-XX00YY-227	Üçlü Çerçeve	12	120	125,50
404-XX00YY-228	Dörtlü Çerçeve	12	120	161,50
404-XX00YY-250	Beşli Çerçeve	12	48	194,00

404-XX00YY-096

XX - Üst çerçeve kodu karşılığı : 01 = Beyaz, YY - Alt çerçeve kodu karşılığı : 03 = Koyu Gri, 06 = Kese Kağıdı, 08 = Siyah

Çoklu çerçeveler yatay ve dikey kullanıma uygundur. Loft serisi, (Mekanizma + Tuş / Kapak) ve (Çerçeve) şeklinde 2 parça olarak satılmaktadır.



600-0002XX-200

XX - Kodu karşılığı : 01 = Beyaz, 02 = Krem

Anahtar, priz mekanizmalar, (Mekanizma + Tuş / Kapak) ve (Çerçeve) şeklinde 2 parça olarak satılmaktadır. Farklı "Energy Saver" çeşitleri için lütfen firmamız ile iletişime geçiniz.



Beyaz

600-000201-200



Krem

600-000202-200

NATURAL MEKANİZMA
FİYATLARI



Referans No	Ürün Adı (Mekanizma + Tuş/Kapak)	Kutudaki Adet	Kolideki Adet	Liste Fiyatı (TL)
Anahtar Grubu				
600-0002XX-200	Anahtar	12	120	73,50
600-0002XX-202	Komütatör	12	120	99,00
600-0002XX-205	Light Anahtarı	12	120	86,50
600-0002XX-204	Kapı Otomatığı Anahtarı	12	120	86,50
600-0002XX-207	Zil Anahtarı	12	120	86,50
600-0002XX-209	Veavien	12	120	99,50
600-0002XX-211	Komütatör Veavien	12	120	148,50
600-0002XX-214	Permütatör (Ara Veavien)	12	120	141,50
600-0002XX-254	Üçlü Anahtar	12	120	137,00
600-0002XX-216	Jaluzi Kumanda Anahtarı	12	120	171,50
600-0022XX-216	Yaysız Jaluzi Kumanda Anahtarı	12	120	181,50
600-0002XX-220	İmplus Komütatör (Light + Light)	12	120	166,50
600-0002XX-251	DND/MUR İç Ünite Komütatör	12	120	175,50
600-0002XX-252	Müzik Yayın Anahtarı	12	120	918,00



Led Işıklı Anahtar

600-0002XX-201	Işıklı Anahtar	12	60	146,50
600-0002XX-203	Işıklı Komütatör	12	60	167,00
600-0002XX-206	Işıklı Light Anahtarı	12	60	146,50
600-0002XX-210	Işıklı Veavien	12	60	158,50

Slim Anahtar Grubu

610-0002XX-200	Anahtar	12	120	97,00
610-0002XX-202	Komütatör	12	120	130,00
610-0002XX-205	Light Anahtarı	12	120	110,00
610-0002XX-204	Kapı Otomatığı Anahtarı	12	120	110,00
610-0002XX-207	Zil Anahtarı	12	120	110,00
610-0002XX-209	Veavien	12	120	125,00
610-0002XX-211	Komütatör Veavien	12	60	170,00
610-0002XX-254	Üçlü Anahtar	12	60	168,00
610-0002XX-216	Jaluzi Kumanda Anahtarı	12	60	217,00
610-0002XX-214	Permütatör (Ara Veavien)	12	60	161,00
610-0002XX-220	İmplus Komütatör (Light + Light)	12	60	166,50

Priz Grubu

600-0003XX-217	Topraklı Priz	12	120	99,50
600-0003XX-218	Topraklı Priz (Çocuk Korumalı)	12	120	135,00
600-0003XX-249	Kapaklı Topraklı Priz	12	120	132,50
600-0003XX-243	Kapaklı Topraklı Priz (Çocuk Korumalı)	12	120	151,00
600-0003XX-219	Ups Topraklı Priz (Çocuk Korumalı)	12	120	151,00
600-000301-907	İkili Topraklı Priz (Modül + Kapak)	12	72	160,00
600-0003XX-245	1X USB Şarj Prizi 5V-2A	12	60	1.252,50
600-0003XX-247	2X USB Şarj Prizi 5V-2A	12	60	1.485,50
400-XX0300-907	Mina İkili Topraklı Priz (ÇİRCİVELİ)	12	72	174,50

Referans No	Ürün Adı (Mekanizma + Tuş/Kapak)	Kutudaki Adet	Kolideki Adet	Liste Fiyatı (TL)
TV - Uydu - Sat Prizleri				
600-0003XX-237	TV Anten Prizi (Ekranlı Geçişli)	12	120	158,00
600-0003XX-238	TV Anten Prizi (Ekranlı Sonlu)	12	120	158,00
600-0003XX-231	Uydu Prizi (Tekli, F Tipi Konnektör, Sonlu)	12	120	126,50
600-0003XX-232	Uydu Prizi (Tekli, F Tipi Konnektör, Ekranlı)	12	120	244,00
600-0003XX-239	TV - Sat Prizi, İkili (Geçişli)	12	60	686,00
600-0003XX-240	TV - Sat Prizi, İkili (Sonlu)	12	60	686,00
600-0003XX-241	Kablo Çıkışı	12	60	82,50

İletişim Priz Grubu

600-0003XX-221	Nümeris Telefon Prizi (1*RJ11-623 Kablolu , 4 Kontaklı)	12	120	121,00
600-0003XX-223	Nümeris Telefon Priz (1*RJ11 - Cat 3 Kablosuz	12	120	148,50
600-0003XX-222	kili Nümeris Telefon Priz (2*RJ11 - Cat 3)	12	120	218,50
600-0003XX-234	Data + Nümeris (Cat 6 + RJ11 Cat 3)	12	120	385,00
600-0003XX-229	Tekli Data Prizi (1*RJ45 Cat6)	12	120	318,00
600-0003XX-230	İkili Data Prizi (2*RJ45 Cat6)	12	120	547,50
600-0003XX-233	Data Priz (Jaksız)	12	120	105,50
600-0003XX-236	1X HDMI Prizi	12	120	608,00
600-0003XX-269	2XHDMI Prizi	12	120	912,00
600-0003XX-242	Data + HDMI Prizi	12	120	1.079,50
600-0003XX-244	Data + USB Data Prizi	12	120	990,50
600-0003XX-255	1XFiber Optik	12	120	255,00
600-0003XX-270	2XFiber Optik	12	120	382,50
600-0003XX-235	USB Data Prizi	12	120	361,00

Dimmerler

600-0003XX-212	Dimmer 800W	12	120	1.087,00
600-0003XX-248	Dimmer 500W (Veavien)	12	120	1.756,50

Elektronik Ürünler

600-0003XX-262	Energy Saver Mikro Switch Gecikmeli	12	120	1.848,00
600-0003XX-263	Energy Saver Mikro Switch	12	120	1.129,50
200-000100-007	11 Pinli 3x10 A Röle	12	120	3.250,00
120-011803-103	Optik Yedek Pvc Kart	12	120	240,00



SIVAÜSTÜ NİVO
FİYATLARI

Referans No	Ürün Adı (Mekanizma + Tuş/Kapak)	Kutudaki Adet	Kolideki Adet	Liste Fiyatı (TL)
-------------	----------------------------------	---------------	---------------	---------------------

Anahtar Grubu

402-010000-200	Anahtar	12	120	87,00
402-010000-202	Komütatör	12	120	103,00
402-010000-205	Light Anahtarı	12	120	89,50
402-010000-204	Kapı Otomatığı Anahtarı	12	120	89,50
402-010000-207	Zil Anahtarı	12	120	89,50
402-010000-209	Veavien	12	120	101,00
402-010000-254	Üçlü Anahtar	12	120	141,50

Priz Grubu

402-010000-254	Topraklı Priz	12	120	104,50
402-010000-218	Topraklı Priz (Çocuk Korumalı)	12	120	124,00
402-010000-243	Kapaklı Topraklı Priz (Çocuk Korumalı)	12	120	131,50
402-010000-249	Kapaklı Topraklı Priz	12	72	115,00

TV - Uydu - Sat Prizleri

402-010000-231	Uydu Prizi (Tekli, F Tipi Konnektör, Sonlu)	12	120	117,50
----------------	---------------------------------------------	----	-----	--------

İletişim Priz Grubu

402-010000-221	Nümeris Telefon Prizi (1*RJ11-623K, 4 Kontaklı)	12	120	104,50
----------------	-------------------------------------------------	----	-----	--------

Kombine Ürünler

402-010000-910	Anahtar + Topraklı Priz	12	72	172,50
402-010000-912	Komitatör + Topraklı Priz	12	72	183,00
402-010000-914	Anahtar + Kapaklı Topraklı Priz	12	72	177,50
402-010000-915	Komitatör + Kapaklı Topraklı Priz	12	72	190,50

2'Li Topraklı Grup Prizler

Referans No

Ürün Adı

Kolideki Adet

Liste Fiyatı (TL)



700-000000-112	İkili Topraklı Priz Klemensli	72	140,00
700-000150-112	İkili Topraklı Priz 1,5mt	12	357,00
700-000300-112	İkili Topraklı Priz 3mt	12	482,50
700-000500-112	İkili Topraklı Priz 5mt	12	686,00

3'Lü Topraklı Grup Prizler



700-000000-113	Üçlü Topraklı Priz Klemensli	60	189,50
700-000150-113	Üçlü Topraklı Priz 1,5mt	12	406,50
700-000300-113	Üçlü Topraklı Priz 3mt	12	519,50
700-000500-113	Üçlü Topraklı Priz 5mt	12	719,00

Anahtarlı



700-000000-123	Üçlü Topraklı Anahtarlı Priz Klemensli	48	493,00
700-000150-123	Üçlü Topraklı Anahtarlı Priz 1,5mt	15	710,00
700-000300-123	Üçlü Topraklı Anahtarlı Priz 3mt	15	785,50
700-000500-123	Üçlü Topraklı Anahtarlı Priz 5mt	12	931,00

4'Lü Topraklı Grup Prizler



700-000000-114	Dörtlü Topraklı Priz Klemensli	42	241,00
700-000150-114	Dörtlü Topraklı Priz 1,5mt	15	456,00
700-000300-114	Dörtlü Topraklı Priz 3mt	15	552,50
700-000500-114	Dörtlü Topraklı Priz 5mt	12	747,50

Anahtarlı



700-000000-124	Dörtlü Topraklı Anahtarlı Priz Klemensli	40	545,50
700-000150-124	Dörtlü Topraklı Anahtarlı Priz 1,5mt	15	762,00
700-000300-124	Dörtlü Topraklı Anahtarlı Priz 3mt	15	836,00
700-000500-124	Dörtlü Topraklı Anahtarlı Priz 5mt	12	984,50

6'Li Topraklı Grup Prizler



700-000000-116	Altılı Topraklı Priz Klemensli	36	343,50
700-000150-116	Altılı Topraklı Priz 1,5mt	15	558,00
700-000300-116	Altılı Topraklı Priz 3mt	15	631,00
700-000500-116	Altılı Topraklı Priz 5mt	12	818,50

Anahtarlı



700-000000-126	Altılı Topraklı Anahtarlı Priz Klemensli	32	644,50
700-000150-126	Altılı Topraklı Anahtarlı Priz 1,5mt	15	858,50
700-000300-126	Altılı Topraklı Anahtarlı Priz 3mt	15	931,50
700-000500-126	Altılı Topraklı Anahtarlı Priz 5mt	12	1.080,00

**2'Li Çocuk Korumalı
Topraklı Grup Prizler**

Referans No

Ürün Adı

Kolideki Adet

Liste Fiyatı (TL)



700-000000-312	İkili Çocuk.kor Topraklı Priz Klemensli	72	141,50
700-000150-312	İkili Çocuk.kor Topraklı Priz 1,5mt	12	358,50
700-000300-312	İkili Çocuk.kor Topraklı Priz 3mt	12	493,50
700-000500-312	İkili Çocuk.kor Topraklı Priz 5mt	12	697,00

**3'Lü Çocuk Korumalı
Topraklı Grup Prizler**

700-000000-313	Üçlü Çocuk.kor Topraklı Priz Klemensli	60	192,00
700-000150-313	Üçlü Çocuk.kor Topraklı Priz 1,5mt	12	409,00
700-000300-313	Üçlü Çocuk.kor Topraklı Priz 3mt	12	534,50
700-000500-313	Üçlü Çocuk.kor Topraklı Priz 5mt	12	734,00

Anahtarlı

700-000000-323	Üçlü Çocuk.kor Topraklı Anahtarlı Priz Klemensli	48	497,50
700-000150-323	Üçlü Çocuk.kor Topraklı Anahtarlı Priz 1,5mt	15	712,50
700-000300-323	Üçlü Çocuk.kor Topraklı Anahtarlı Priz 3mt	15	786,50
700-000500-323	Üçlü Çocuk.kor Topraklı Anahtarlı Priz 5mt	12	934,50

**4'Lü Çocuk Korumalı
Topraklı Grup Prizler**

700-000000-314	Dörtlü Çocuk.kor Topraklı Priz Klemensli	42	244,50
700-000150-314	Dörtlü Çocuk.kor Topraklı Priz 1,5mt	15	459,00
700-000300-314	Dörtlü Çocuk.kor Topraklı Priz 3mt	15	571,50
700-000500-314	Dörtlü Çocuk.kor Topraklı Priz 5mt	12	766,50

Anahtarlı

700-000000-324	Dörtlü Çocuk.kor Topraklı Anahtarlı Priz Klemensli	40	550,50
700-000150-324	Dörtlü Çocuk.kor Topraklı Anahtarlı Priz 1,5mt	15	765,50
700-000300-324	Dörtlü Çocuk.kor Topraklı Anahtarlı Priz 3mt	15	839,50
700-000500-324	Dörtlü Çocuk.kor Topraklı Anahtarlı Priz 5mt	12	987,50

**6'Lı Çocuk Korumalı
Topraklı Grup Prizler**

700-000000-316	Altılı Çocuk.kor Topraklı Priz Klemensli	36	348,00
700-000150-316	Altılı Çocuk.kor Topraklı Priz 1,5mt	15	562,50
700-000300-316	Altılı Çocuk.kor Topraklı Priz 3mt	15	645,50
700-000500-316	Altılı Çocuk.kor Topraklı Priz 5mt	12	842,00

Anahtarlı

700-000000-326	Altılı Çocuk.kor Topraklı Anahtarlı Priz Klemensli	32	649,50
700-000150-326	Altılı Çocuk.kor Topraklı Anahtarlı Priz 1,5mt	15	863,50
700-000300-326	Altılı Çocuk.kor Topraklı Anahtarlı Priz 3mt	15	936,50
700-000500-326	Altılı Çocuk.kor Topraklı Anahtarlı Priz 5mt	12	1.084,50

SIVAALTI SIGORTA KUTUSU



EK APARAT

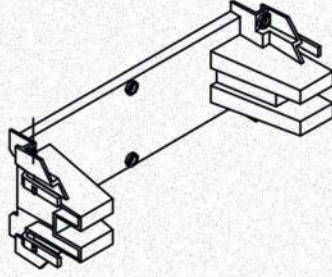

RAY

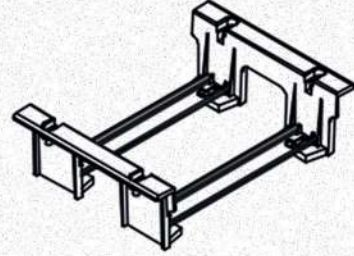

$$24_M + 24_M = 48_M$$

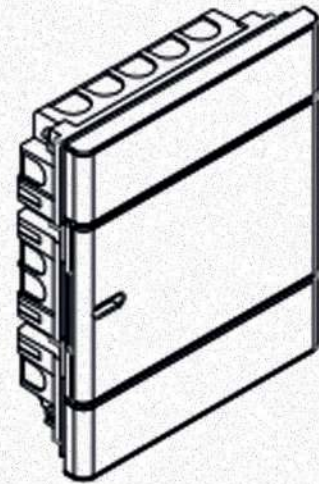
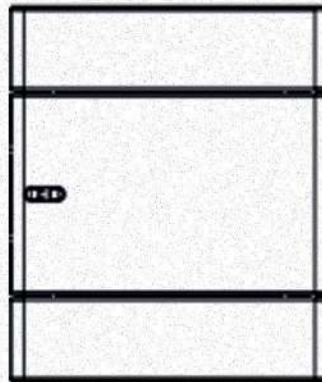
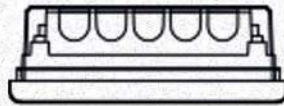
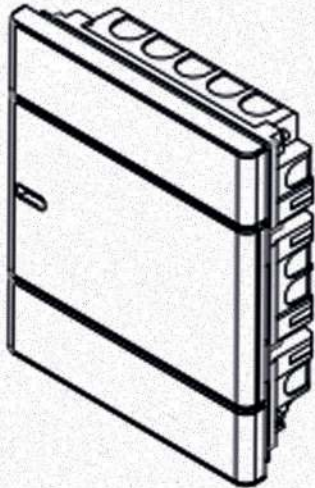

halogen
free

+60 C
-20 C

termoplast

IP40



SIVAALTI SİGORTA KUTUSU

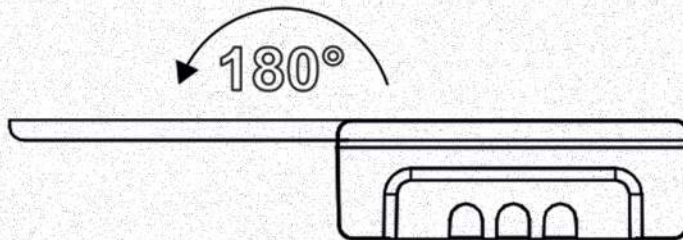
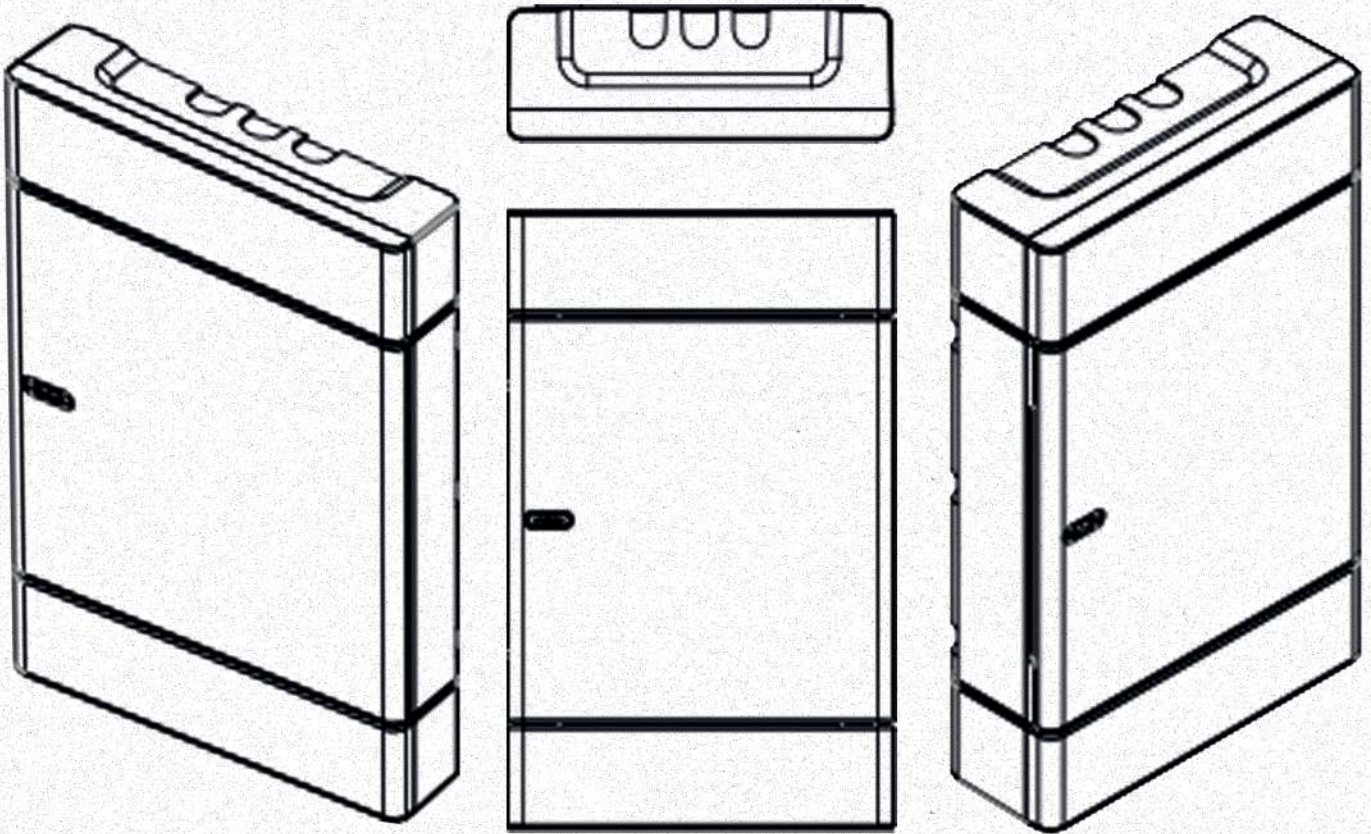

halogen free	+60 C -20 C	termoplast	IP40 
-----------------	----------------	------------	-----------------------------------------------------------------------------------------------

Sigorta Kutuları Sıva Altı



4'lü Sıva Altı,
Sigorta Kutusu



6'li Sıva Altı,
Sigorta Kutusu



8'li Sıva Altı,
Sigorta Kutusu



12'li Sıva Altı,
Sigorta Kutusu



18'li Sıva Altı,
Sigorta Kutusu



24'lü Sıva Altı,
Sigorta Kutusu



36'lı Sıva Altı,
Sigorta Kutusu

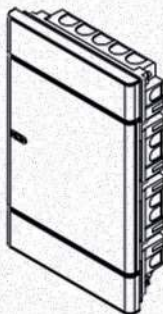

Referans No

Ürün Adı

Liste Fiyatı
(TL)

330-010200-004	4'lü Sıva Altı Sigorta Kutusu	303,00
330-010200-006	6'li Sıva Altı Sigorta Kutusu	398,50
330-010200-008	8'li Sıva Altı Sigorta Kutusu	466,50
330-010200-012	12'li Sıva Altı Sigorta Kutusu	617,00
330-010200-018	18'li Sıva Altı Sigorta Kutusu	772,50
330-010200-024	24'lü Sıva Altı Sigorta Kutusu	961,50
330-010200-036	36'lı Sıva Altı Sigorta Kutusu	1.472,00
330-010200-048	48'li Sıva Altı Sigorta Kutusu	1.971,00
330-010200-072	72'li Sıva Altı Sigorta Kutusu	2.948,00

Sigorta Kutuları Sıva Üstü



4'lü Sıva Üstü,
Sigorta Kutusu



6'lı Sıva Üstü,
Sigorta Kutusu



8'li Sıva Üstü,
Sigorta Kutusu



12'li Sıva Üstü,
Sigorta Kutusu



18'li Sıva Üstü,
Sigorta Kutusu



24'lü Sıva Üstü,
Sigorta Kutusu



36'lı Sıva Üstü,
Sigorta Kutusu

Sıva Üstü Sigorta Kutuları

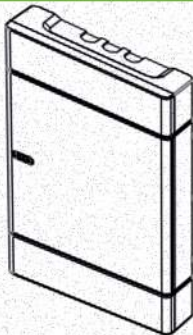

Referans No

Ürün Adı

Liste Fiyatı
(TL)

330-010100-004	4'lü Sıva Üstü Sigorta Kutusu	312,50
330-010100-006	6'lı Sıva Üstü Sigorta Kutusu	398,00
330-010100-008	8'li Sıva Üstü Sigorta Kutusu	481,50
330-010100-012	12'li Sıva Üstü Sigorta Kutusu	649,50
330-010100-018	18'li Sıva Üstü Sigorta Kutusu	868,00
330-010100-024	24'lü Sıva Üstü Sigorta Kutusu	923,00
330-010100-036	36'lı Sıva Üstü Sigorta Kutusu	1.401,00

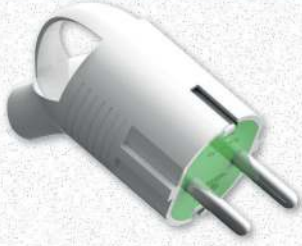
Aksesuar
Grubu

701-000000-003



701-000000-001



701-000000-004



701-000000-002



701-000000-005



701-000000-006

Fişler

Referans No

Ürün Adı

Kutudaki
AdetKolideki
AdetListe Fiyatı
(TL)

701-000000-001	Dişi Fiş Topraklı	50	400	85,00
701-000000-002	Erkek Fiş Topraklı	40	400	64,00
701-000000-003	Kulplu Fiş Topraklı	40	400	64,00
701-000000-004	Monoblok Fiş Topraklı	40	400	64,00
701-000000-006	2 Li Golyad	12	72	181,50
701-000000-005	3 Lü Golyad	12	96	245,00

OVIVO

ELECTRIC

Hakkımızda

- 1987 - Hırdavat malzemeleri satmak üzere İstanbul'da kuruldu.
- 1993 - Portföyüne elektrik malzemeleri de ilave ederek ürün yelpazesini genişletti.
- 1996 - ELBI markasıyla Anahtar - Priz üretimine başladı.
- 2002 - Arnavutköy fabrikası açıldı.
- 2007 - Finlandiya'lı Ahlström Capital ile ortaklık anlaşması imzaladı.
- 2009 - BDY Elektrik (OVİVO) Aydınlatma fabrikası kuruldu.
- 2012 - Ahlström Capital'e ELBI hisseleri devredildi.
- 2015 - Arnavutköy yeni üretim tesislerine taşındı.
- 2016 - Tamamen yeni ve farklı tasarımlarla tekrar OVİVO markasıyla Anahtar - Priz üretimine başladı.

Misyonumuz

Ürünlerini uluslararası kalite standartlarında, farklı tasarımlarla, güvenliği öncelik olan modellerle ve rekabetçi fiyatlarla üreterek sektöründe güçlü bir dünya markası olmak.

Vizyonumuz

Yurt içi ve yurt dışı pazarlarda aranan lider bir Türkiye markası olmak.

Prensiplerimiz

- Müşteri Memnuniyeti: Her şey müşterilerimizin memnuniyeti için.
- Yurt içi ve yurt dışında satış ve sonrası hizmetlerde maksimum memnuniyet sağlamak ana prensibimizdir.
- Ürün Güvenliği: Uluslararası standartlarda ailemizin güvenliğini sağlayan ürünler üretiyoruz.
- Kalite: Başarımızın arkasında uluslararası standartlarda üretim ve hizmette maksimum kaliteyi sunma yattıyor.
- Çalışanlarımız: Mutfağımızın ustaları. Hepsi ailemizin birer ferdi. Gücümüzü onların müthiş performanslarından alıyoruz.
- Tasarım: İnovatif ve farklı tasarım ürünlerimiz ile görsellik ve kullanım rahatlığı ve farkındalığı sağlamayı hedefledik.
- İş Güvenliği: Çalışanlarımızın güvenli, sağlıklı ve keyifli bir ortamda çalışmalarını ile maksimum verimliliğini hedefliyoruz.

OVIVO

ELECTRIC

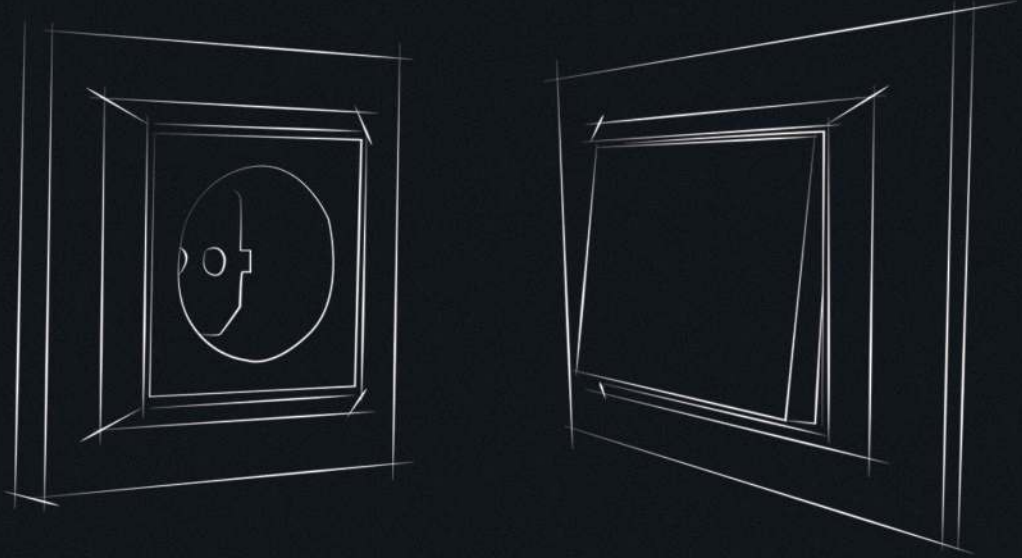

BDY ELEKTRİK
İTHALAT İHRACAT SAN. TİC. LTD. ŞTİ.

Hadımköy Mahallesi, Ayasofya Caddesi,
Elvan Sokak, No:3 Arnavutköy/İstanbul

Telefon : +90 212 682 21 06 (pbx)

Fax : +90 212 682 21 09



www.ovivoelektrik.com.tr